

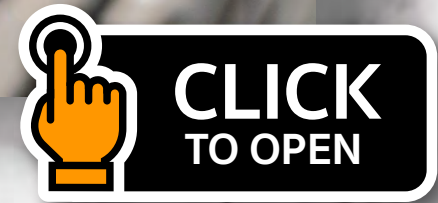

Wooden Blinds ไม้มู่ลี่

Rhythm and blues





Rhythm and blues

Wooden Blinds

บ้านมุสลิม



Wooden Blinds Rail | รางมู่ลี่



Rail Box | กล่องรางแบบสอดใบมู่ลี่

- ตัวโครงกล่องสีตามตัวเลือกด้านล่าง
- ปิดหน้ากล่องด้วยใบมู่ลี่ สีเดียวกับ ใบมู่ลี่



Cover Rail box | กล่องครอบรางแบบทำสีตามใบมู่ลี่

- ตัวโครงกล่องทำสี ตามใบมู่ลี่

Ladder Cord 50 mm

| เชือกบันได สำหรับใบมู่ลี่ขนาด 50 มม.

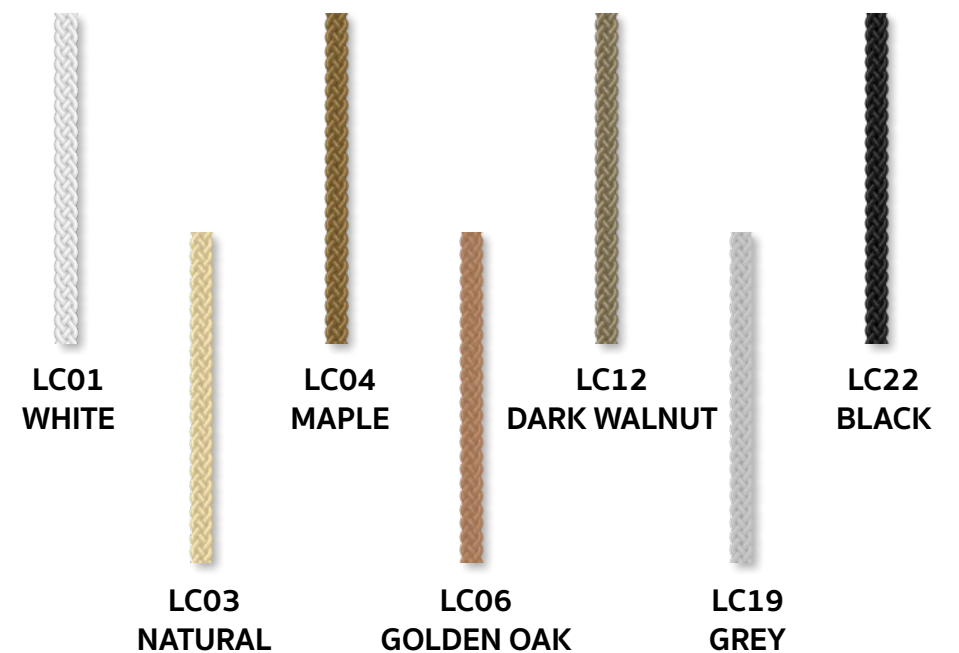

Ladder Tape 35 mm | เทปบันได สำหรับใบมู่ลี่ขนาด 35 มม.

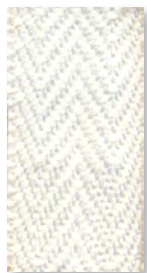

LT3501
WHITE



LT3506
GOLDEN OAK

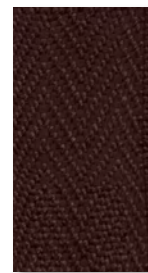

LT3509
PEGON

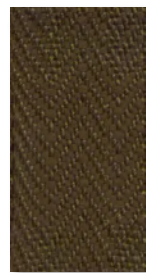

LT3511
WALNUT

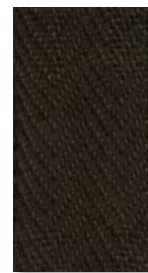

LT3513
TEAK

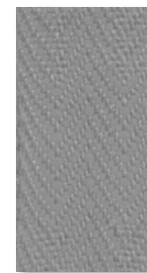

LT3518
LIGHT GREY

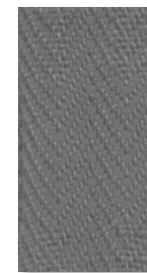

LT3519
GREY

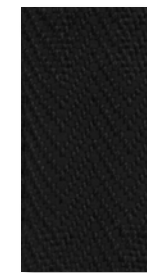

LT3522
BLACK

Ladder Tape 50 mm | เทปบันได สำหรับใบมู่ลี่ขนาด 50 มม.



LT5001
WHITE



LT5002
IVORY

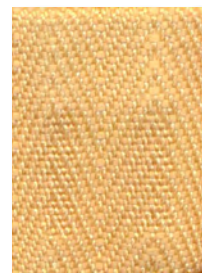

LT5003
NATURAL



LT5004
MAPLE



LT5005
CHERRY



LT5006
GOLDEN OAK



LT5007
TIGER EYES



LT5008
MAHOGANY



LT5009
PEGON

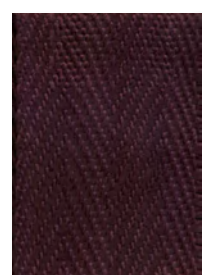

LT5010
MAGENTA

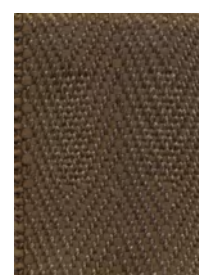

LT5011
WALNUT

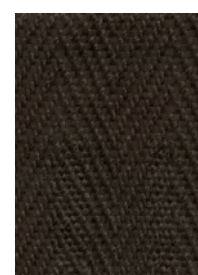

LT5013
TEAK



LT5014
GREEN

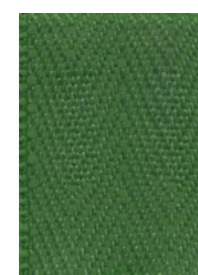

LT5015
FOREST

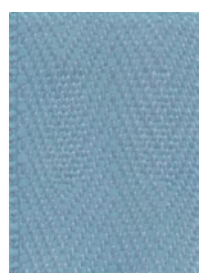

LT5016
SKY

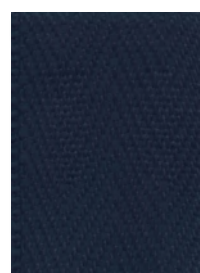

LT5017
DEEP OCEAN



LT5018
LIGHT GREY



LT5019
GREY



LT5021
CHARCOAL



LT5022
BLACK

Wooden Blinds Rope & Handle | เชือกถวนมู่ลี่ และตุ้มจับมู่ลี่

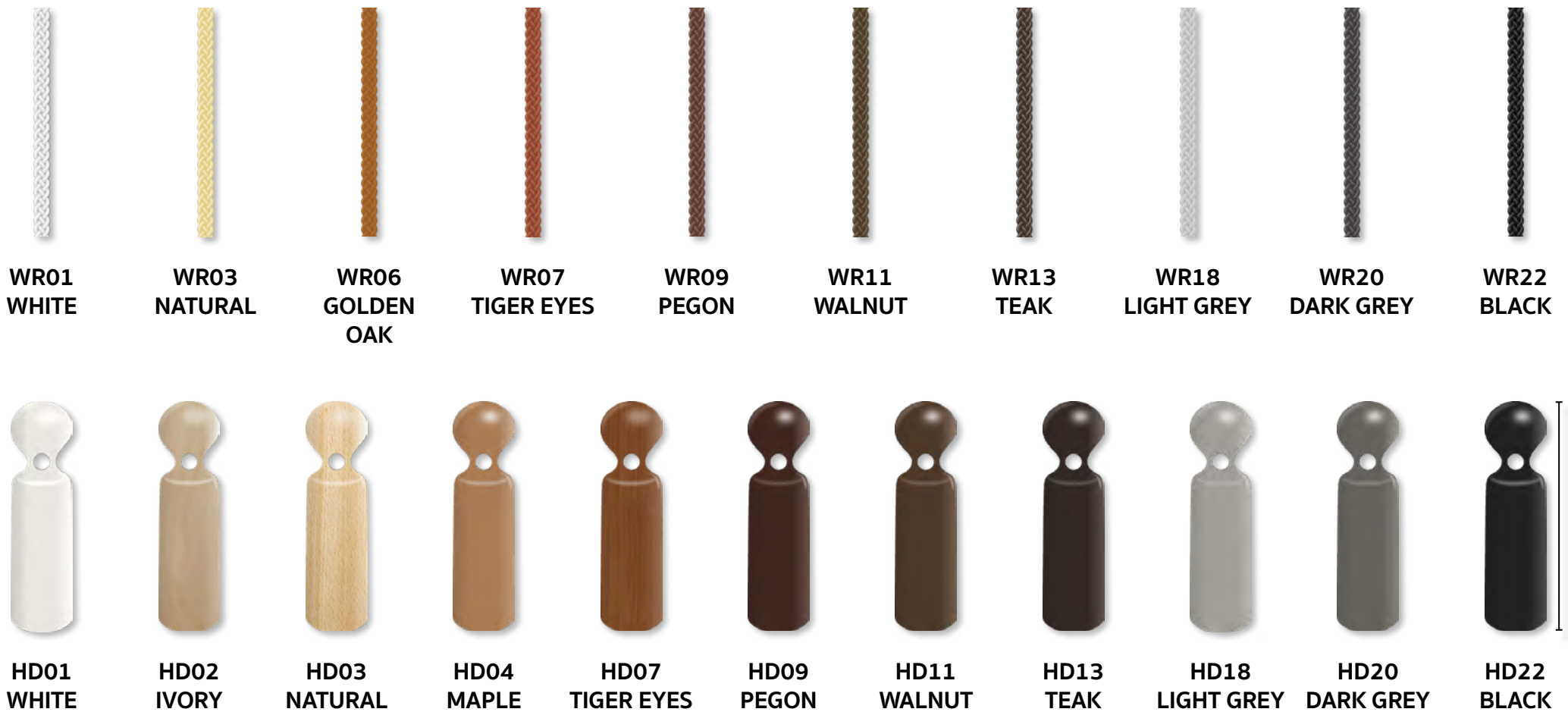

Wooden Blinds Chain | โซ่ถวนมู่ลี่

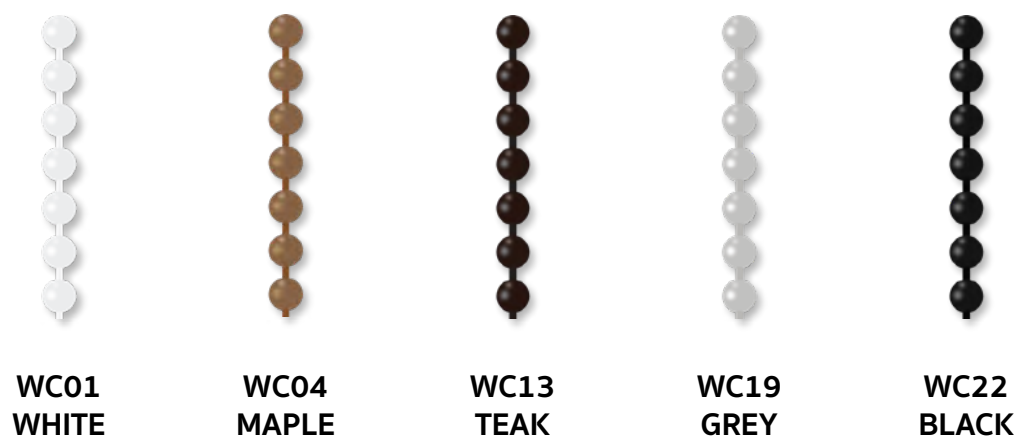

Wooden Blinds Motor System | ระบบมอเตอร์มู่ลี่ไม้

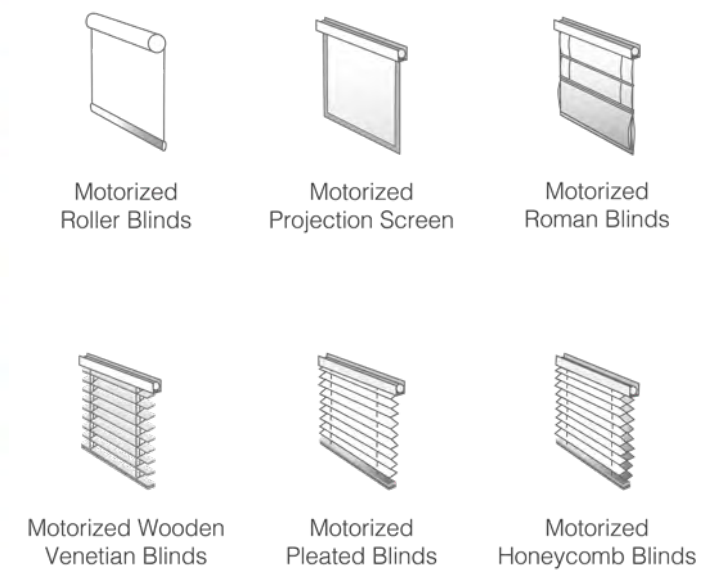
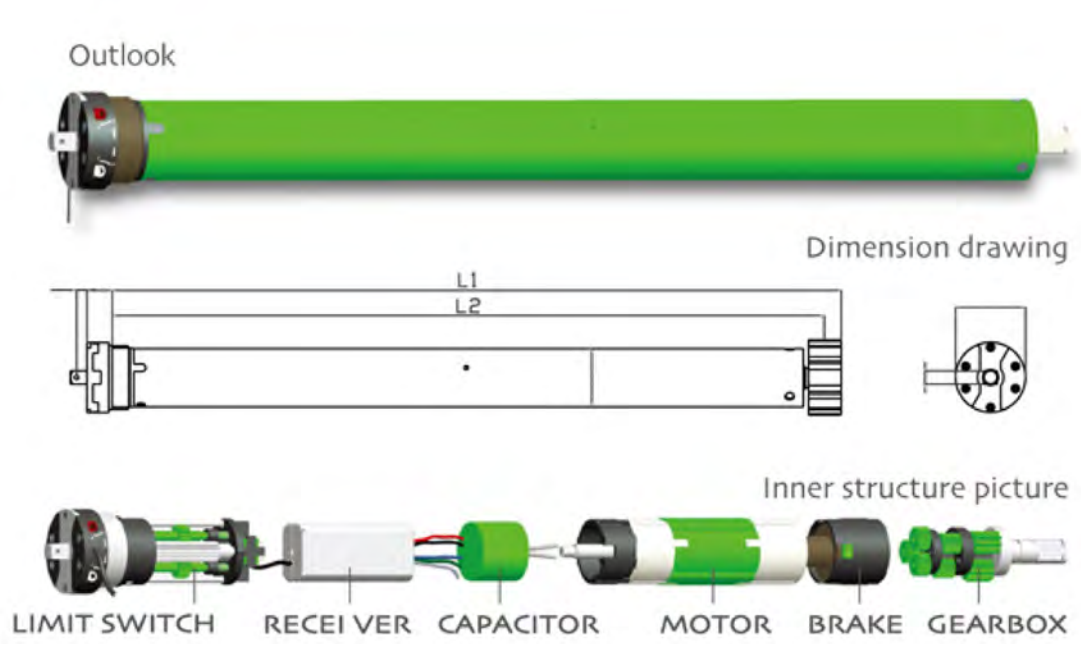

NT35R-6/28

มอเตอร์มู่ลี่ไม้ที่ดีที่สุด มาตรฐานของ Nitas Tessile

- รับประกันมอเตอร์นานสูงสุดถึง 5 ปี
- ระบบมอเตอร์สามารถใช้ได้ทั้ง มู่ลี่แบบแผ่น, มู่ลี่แบบรั้งผึ้ง, มู่ลี่แบบพลีท, ม่านม้วน, แผ่นฉายโปรเจคเตอร์, ม่านโรมัน

รุ่น	แรงบิด	ความเร็ว	แรงดันไฟฟ้า	ความถี่	กำลังไฟฟ้า	รับน้ำหนักสูงสุด
NT35R-6/28	6 N.m	28 rpm	230 V	50 Hz	121 W	25 kg



สวิตช์ติดผนัง 15 ช่องสัญญาณ



รีโมทไร้สาย 15 ช่องสัญญาณ

ระบบการควบคุม

- สวิตช์ ติดผนัง 15 ช่องสัญญาณ
- รีโมทไร้สาย 15 ช่องสัญญาณ

หมายเหตุ ใช้รีซีฟเวอร์บิวอิน



WOODEN BLINDS

ม่านไม้

Design No.	Content	Width (cm)	Height (cm)	Thickness (mm) ±5%	Weight (g/m/pc) ±5%	Standard	Price/Sq.yd
PRW50	Premium Raminwood	40-240	50-400	2.90	50	Formaldehyde Free	2,450
RW50	Raminwood	40-240	50-400	2.80	44	N/A	1,950
BW35	Basswood	40-240	50-400	2.80	54	N/A	1,950
BW50	Basswood	40-240	50-400	2.80	67	N/A	1,950
FW35	Foamwood	40-240	50-400	3.10	50	Water Proof	1,950
FW50	Foamwood	40-240	50-400	3.40	84	Water Proof	1,950

Specification when pull up

Total Height
50 cm
100 cm
150 cm
200 cm
250 cm
300 cm

Basswood, Raminwood

Height when pull up	
Ladder Cord	Ladder Tape
11 cm	12 cm
15 cm	16 cm
20 cm	21 cm
23 cm	24 cm
27 cm	28 cm
31 cm	32 cm

Foamwood

Height when pull up	
Ladder Cord	Ladder Tape
13 cm	14 cm
17 cm	18 cm
22 cm	23 cm
25 cm	26 cm
29 cm	30 cm
33 cm	36 cm

Remark: Total Height is included rail 6 cm

Premium Raminwood

- ใบมู่ลี่คุณภาพสูง เป็นมิตรกับสิ่งแวดล้อม
- ไม่มีกลิ่นฉุน ปลอดภัยระเหยมีพิษ เช่น ฟอรัมาลดีไฮด์
- เหมาะสำหรับบ้านที่มีเด็กเล็ก ผู้สูงอายุ และผู้ป่วยโรคภูมิแพ้



พรีเมียมรามินวู้ด 50 พื้นผิวเรียบ/สีเรียบ



PRW50-112
CREAM



PRW50-115
LIGHT BROWN



PRW50-116
LIGHT GREY

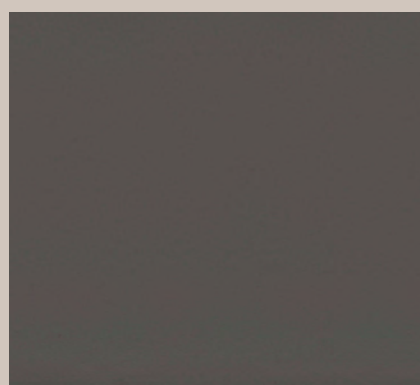

PRW50-118
ASH BROWN

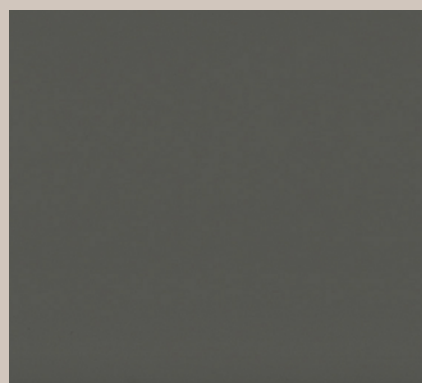

PRW50-117
GREY

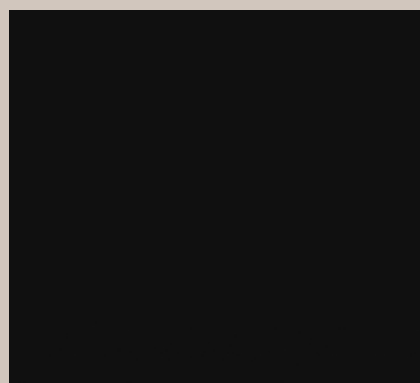

PRW50-120
BLACK

Design Code : **PRW50**

Width : 40-240 cm | Height : 50-400 cm

Content : Premium Raminwood

Weight : 50 g/sqm(±5%)

Purpose : Wooden Blinds (Formaldehyde Free)

Thickness : 2.90 mm(±5%)

Features : Can withstand sunlight, but not water

Price : 2,450 Baht/Sq.yd

พรีเมียมรามินวู้ด 50 พิมพ์ลายไม้



PRW50-830
WHITE MAPLE



PRW50-101
DARK MAPLE



PRW50-102
DARK ASH



PRW50-103
CHERRY



PRW50-202
TEAK



PRW50-866
DARK TEAK



PRW50-800
GOLDEN OAK



รามินวู้ด 50 ไม้สีอ่อน



RW50-101
WHITE



RW50-111
GOLDEN OAK



RW50-103
CHERRY

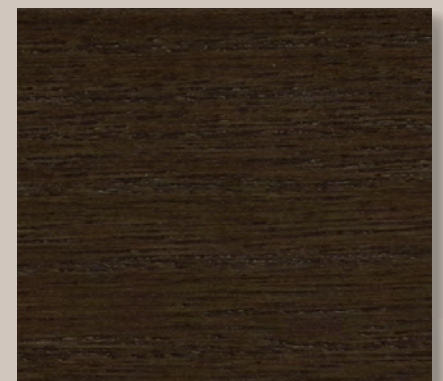

RW50-106
WALNUT



RW50-107
EBONY

Raminwood

- เป็นแผ่นไม้แท้ น้ำหนักเบา ลวดลายสวยงาม
- เหมาะสำหรับพื้นที่หน้าต่าง ที่โดนแสงแดดได้ปกติ
- หลีกเลี่ยงการใช้งานพื้นที่ที่มีความชื้นสูง เช่น ห้องน้ำ



Design Code : **RW50**

Width : 40-240 cm | Height : 50-400 cm

Content : Raminwood

Weight : 44 g/sqm(±5%)

Purpose : Wooden Blinds

Thickness : 2.80 mm(±5%)

Features : Can withstand sunlight, but not water

Price : 1,950 Baht/Sq.yd

Basswood

- เป็นแผ่นไม้แท้ ลวดลายสวยงาม
- เหมาะสำหรับพื้นที่หน้าต่าง โคมแสงแดดได้ปกติ
- หลีกเลี่ยงการใช้งานพื้นที่ที่มีความชื้นสูง เช่น ห้องน้ำ



บาสวู้ด 50 พิมพ์ลายไม้

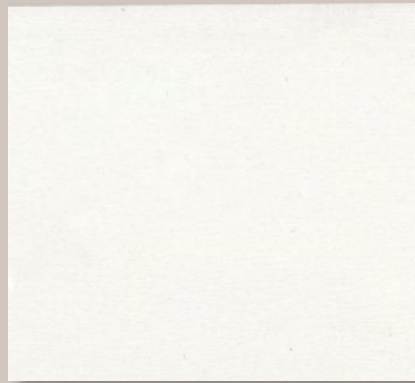

BW50-101
WHITE



BW50-102
BEECH



BW50-103
MAPLE

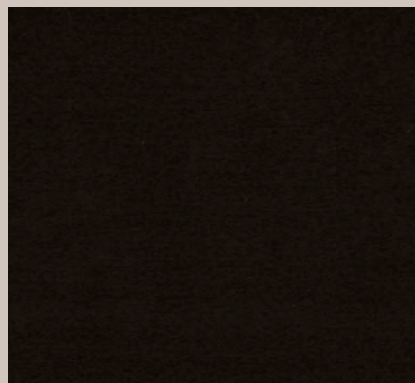

BW50-109
DARK TEAK



BW50-105
GOLDEN TEAK

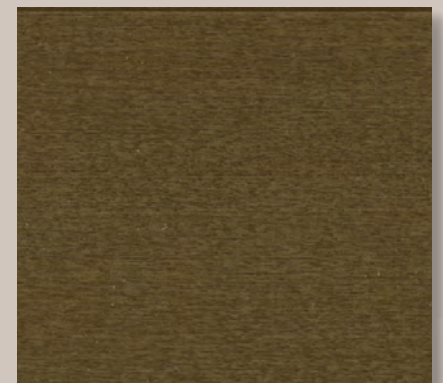

BW50-108
WALNUT



BW50-106
TIGER EYES

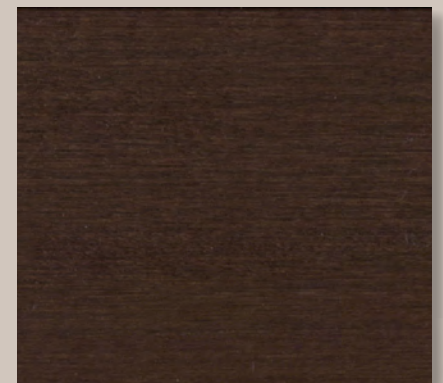

BW50-107
PEGON



BW50- 114
WOOD

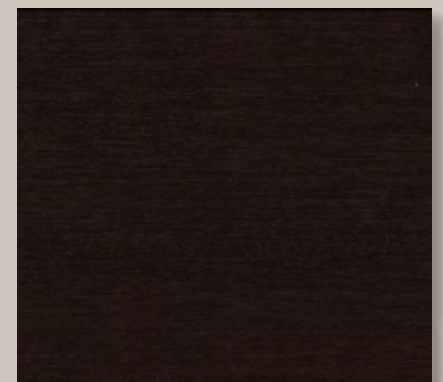

BW50- 112
DARK MAHOGANY

Design Code : **BW50**

Width : 40-240 cm | Height : 50-400 cm

Content : Basswood

Weight : 67 g/sqm(±5%)

Purpose : Wooden Blinds

Thickness : 2.80 mm(±5%)

Features : Can withstand sunlight, but not water

Price : 1,950 Baht/Sq.yd

บาสวู้ด 35

พื้นผิวเรียบ/สีเรียบ

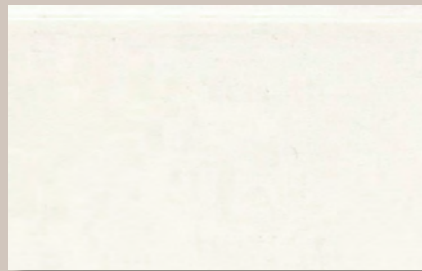

BW35-101
WHITE

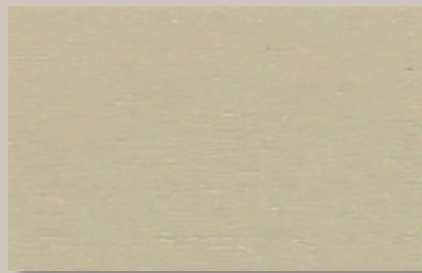

BW35-109
BEIGE



BW35-110
GREY



BW35-104
MAPLE

บาสวู้ด 35 พิมพ์ลายไม้



BW35-103
GOLDEN OAK



BW35-105
WALNUT

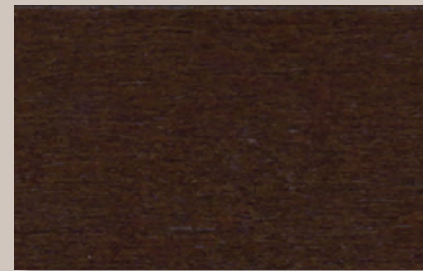

BW35-108
PEGON

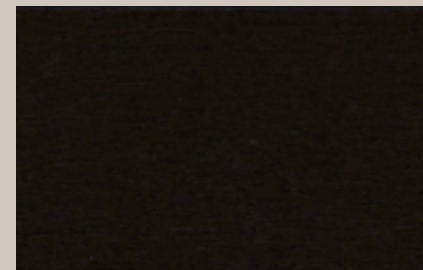

BW35-107
DARK TEAK

Design Code : **BW35**

Width : 40-240 cm | Height : 50-400 cm

Content : Basswood

Weight : 54 g/sqm(±5%)

Purpose : Wooden Blinds

Thickness : 2.80 mm(±5%)

Features : Can withstand sunlight, but not water

Price : 1,950 Baht/Sq.yd





โฟมวู้ด 35 พื้นผิวลายไม้/สีเรียบ



FW35-101
WHITE

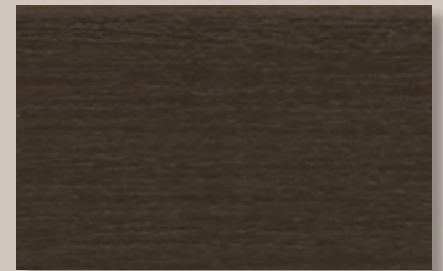

FW35-110
DARK BROWN

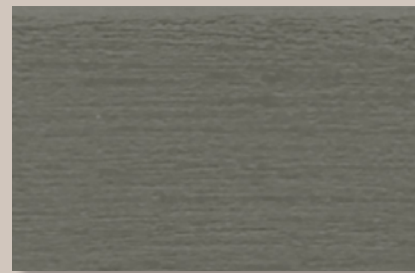

FW35-103
LIGHT GREY

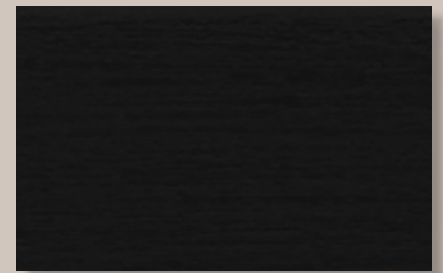

FW35-107
BLACK

Foamwood

- เป็นแผ่นไม้สังเคราะห์ จึงไม่ขึ้นรา
- เหมาะสำหรับใช้ในพื้นที่ ที่มีความชื้นสูง เช่น ห้องน้ำ
- หลีกเลี่ยงการใช้งานที่มีแสงแดดและความร้อนสูง



Design Code : **FW35**

Width : 40-240 cm | Height : 50-400 cm

Content : Foamwood

Weight : 50 g/sqm(±5%)

Purpose : Wooden Blinds

Thickness : 3.10 mm(±5%)

Features : Can withstand water, but strong sunlight

Price : 1,950 Baht/Sq.yd

โฟมวู้ด 50 พื้นผิวเรียบ/สี่เหลี่ยม



FW50-101
WHITE

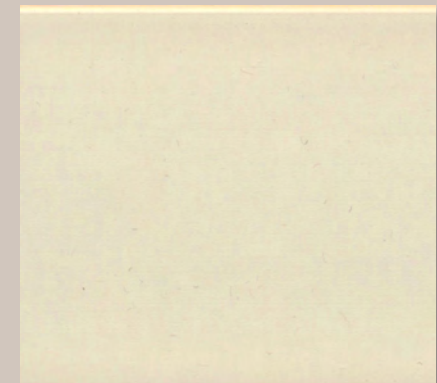

FW50-102
CREAM



FW50-830
LIGHT GREY

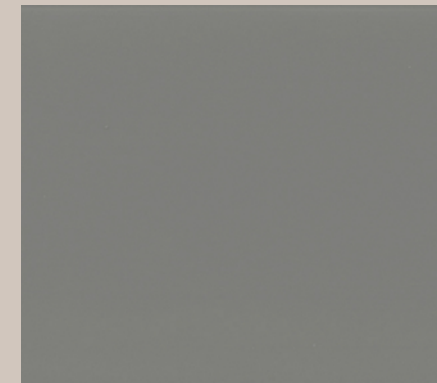

FW50-880
GREY

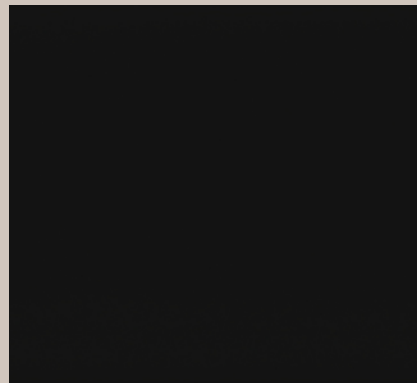

FW50-899
BLACK

Design Code : **FW50**

Width : 40-240 cm | Height : 50-400 cm

Content : Foamwood

Weight : 84 g/sqm(±5%)

Purpose : Wooden Blinds

Thickness : 3.40 mm(±5%)

Features : Can withstand water, but strong sunlight

Price : 1,950 Baht/Sq.yd



ໂຟມວຸ້ດ 50 ພິມຟ້າຍໄມ້



FW50-301
WHITE BEECH



FW50-630
MAHOGANY



FW50-633
DARK WOOD



FW50-628
GOLDEN OAK



FW50-631
PEGON

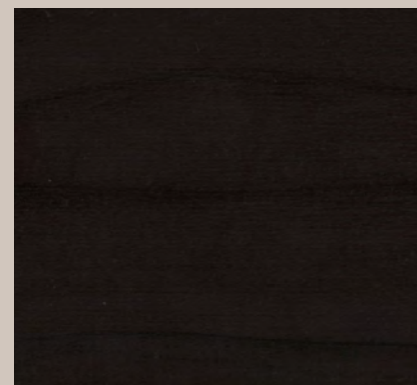

FW50-690
DARK TEAK



FW50-629
GOLDEN TEAK



FW50-750
WOOD

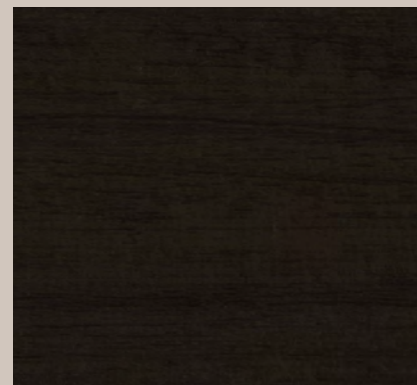

FW50-850
DARK OAK

Design Code : **FW50**

Width : 40-240 cm | Height : 50-400 cm

Content : Foamwood

Weight : 84 g/sqm(±5%)

Purpose : Wooden Blinds

Thickness : 3.40 mm(±5%)

Features : Can withstand water, but strong sunlight

Price : 1,950 Baht/Sq.yd





โฟมวู้ด 50 พื้นผิวลายไม้/สีเรียบ



FW50-012
SKY

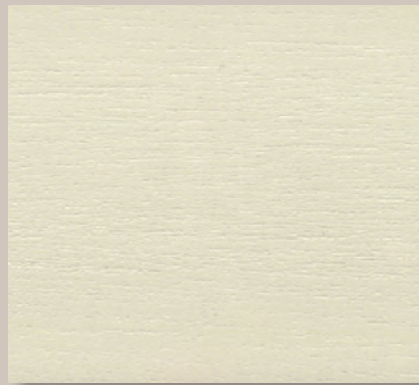

FW50-002
LINEN



FW50-001
SNOW

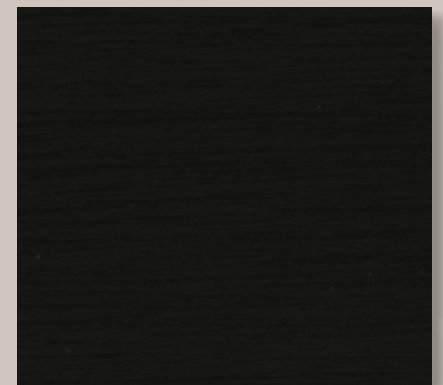

FW50-007
CHARCOAL



FW50-014
DEEP OCEAN

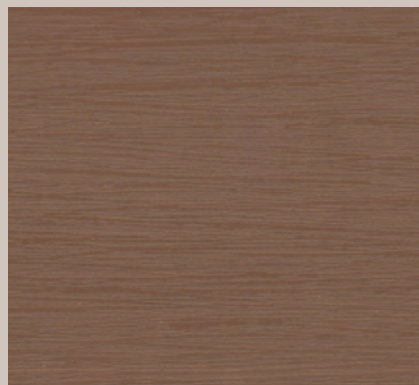

FW50-008
OLD ROSE



FW50-003
MIST

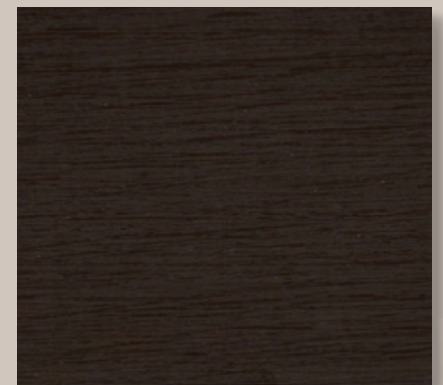

FW50-011
COCOA



FW50-017
FOREST

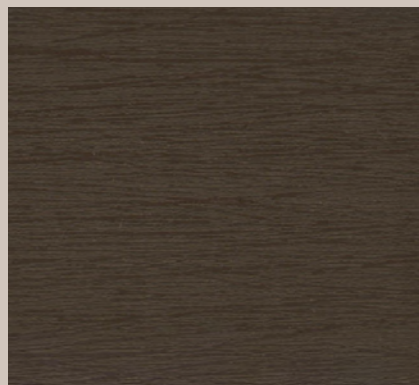

FW50-010
COFFEE



FW50-004
IRON

Design Code : **FW50**

Width : 40-240 cm | Height : 50-400 cm

Content : Foamwood

Weight : 84 g/sqm(±5%)

Purpose : Wooden Blinds

Thickness : 3.40 mm(±5%)

Features : Can withstand water, but strong sunlight

Price : 1,950 Baht/Sq.yd



